

FIRST FLOOR MODIFY FLOOR PLAN
OA DIMENSION 30 X 48

THE WALKER

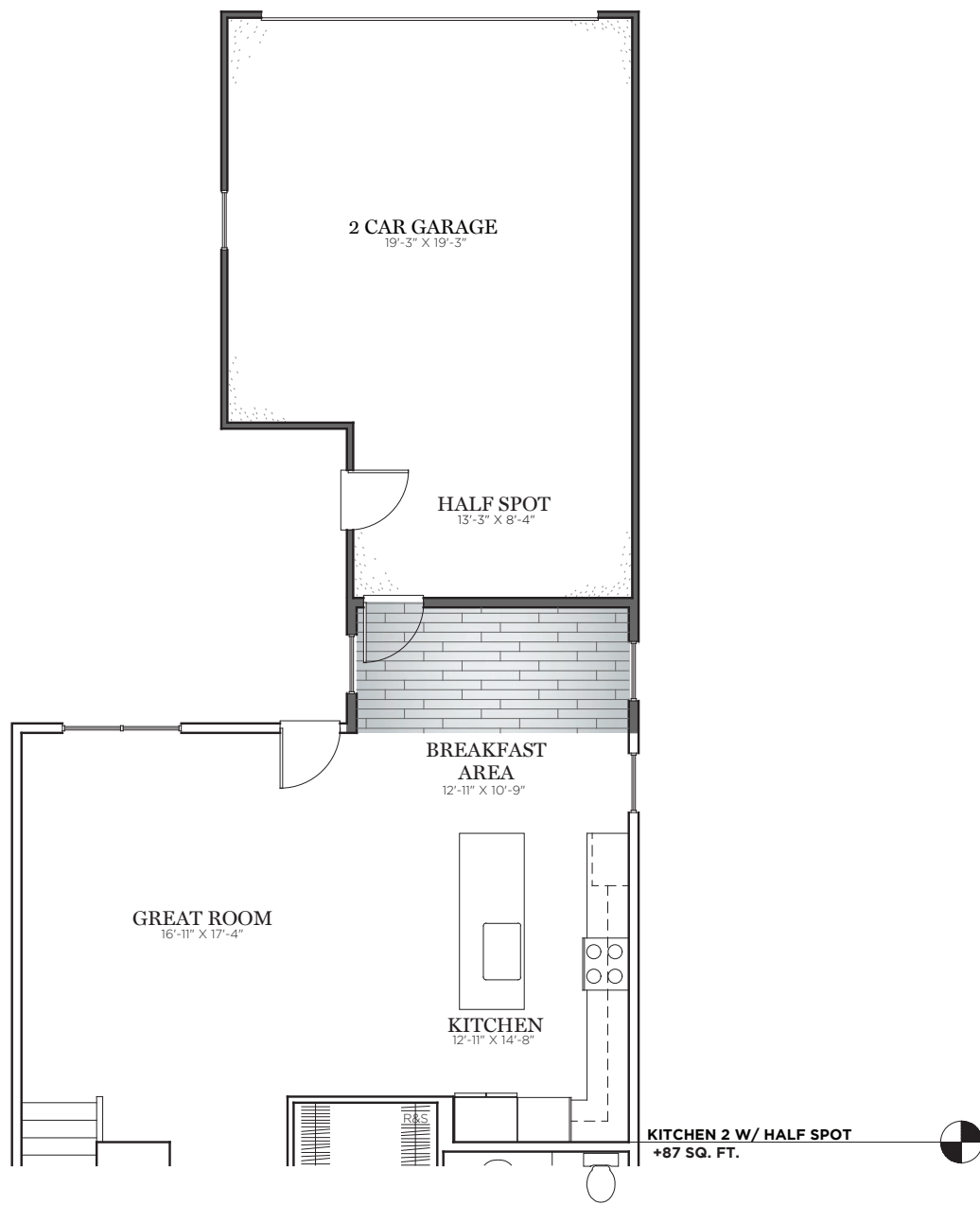

Information included is for illustrative and marketing purposes only. Scale and dimensions are approximate and may vary based on normal construction tolerances. Renderings, materials, finishes and fixtures are intended for space demonstration only. Consult Neighborhood Sales Manager for accurate details based on individual conditions of Purchase Agreement.
© 2016 Charter Homes & Neighborhoods. All rights reserved. Do not duplicate or distribute without written consent. 🏠

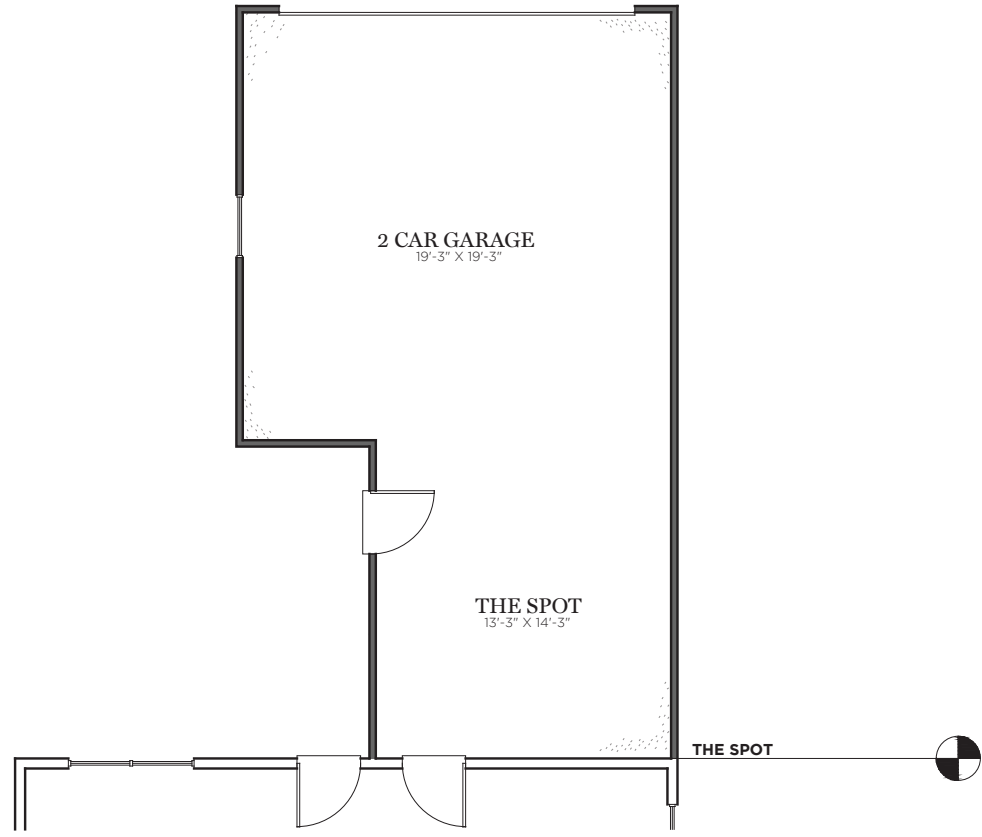

FIRST FLOOR MODIFY FLOOR PLAN
 OA DIMENSION 30 X 48

THE WALKER



CHARTER Homes & Neighborhoods

Information included is for illustrative and marketing purposes only. Scale and dimensions are approximate and may vary based on normal construction tolerances. Renderings, materials, finishes and fixtures are intended for space demonstration only. Consult Neighborhood Sales Manager for accurate details based on individual conditions of Purchase Agreement.

© 2016 Charter Homes & Neighborhoods. All rights reserved. Do not duplicate or distribute without written consent. 🏠

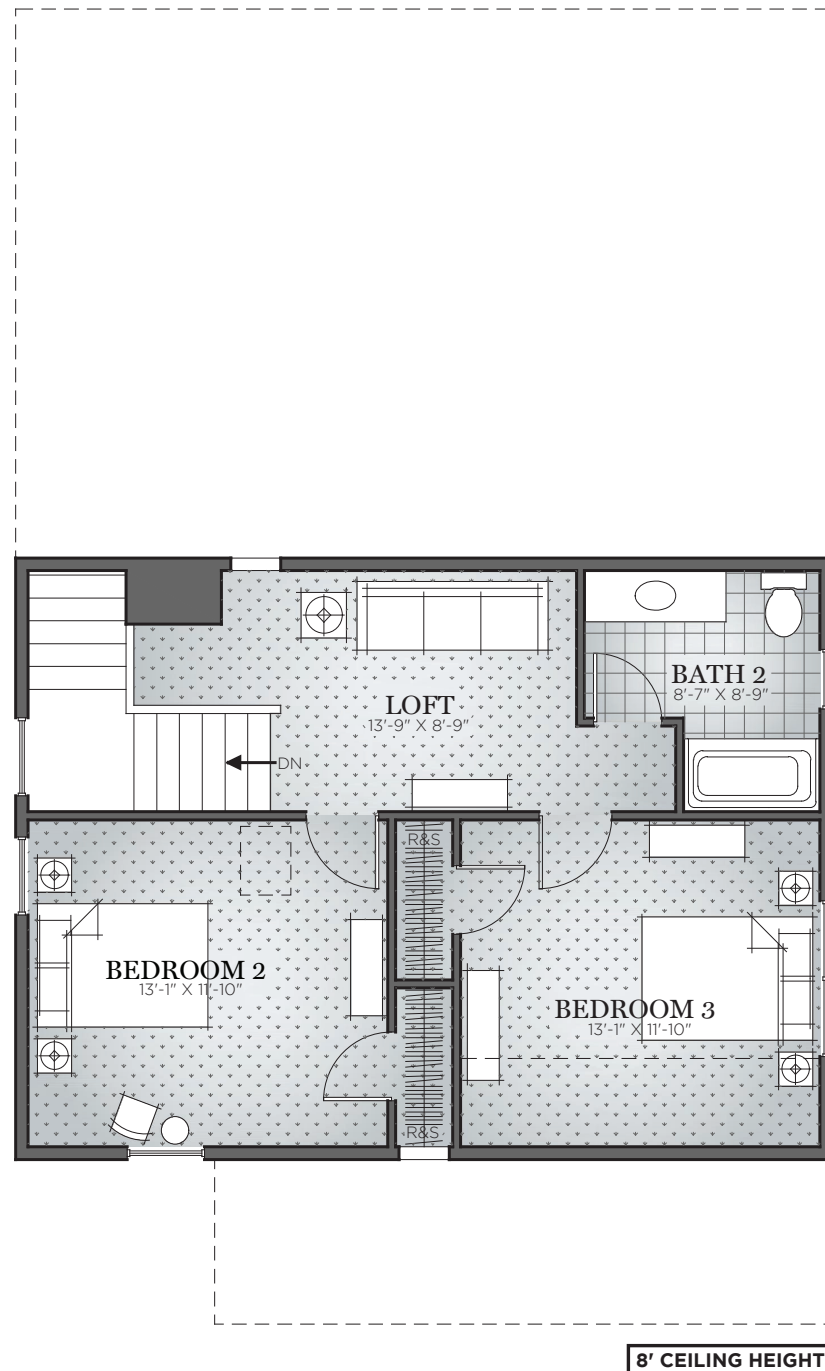

8' CEILING HEIGHT

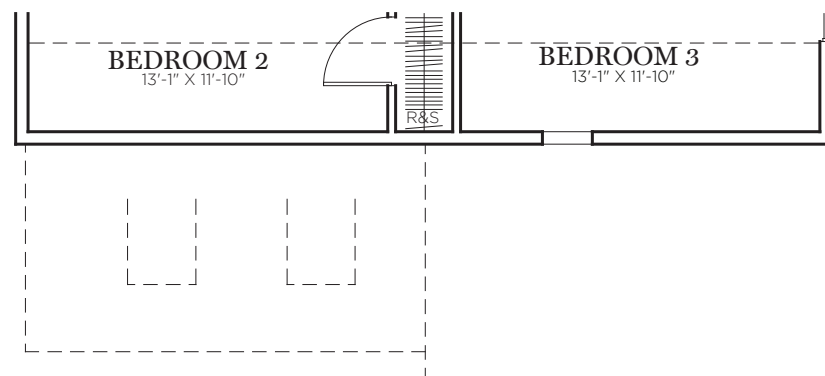

CLASSIC +0 SQ. FT.

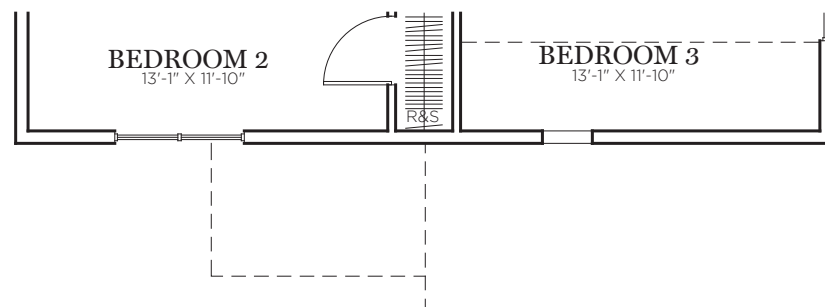

ESTATE +0 SQ. FT.

SECOND FLOOR MODIFY FLOOR PLAN
 OA DIMENSION **30 X 48**

THE WALKER



CHARTER Homes & Neighborhoods

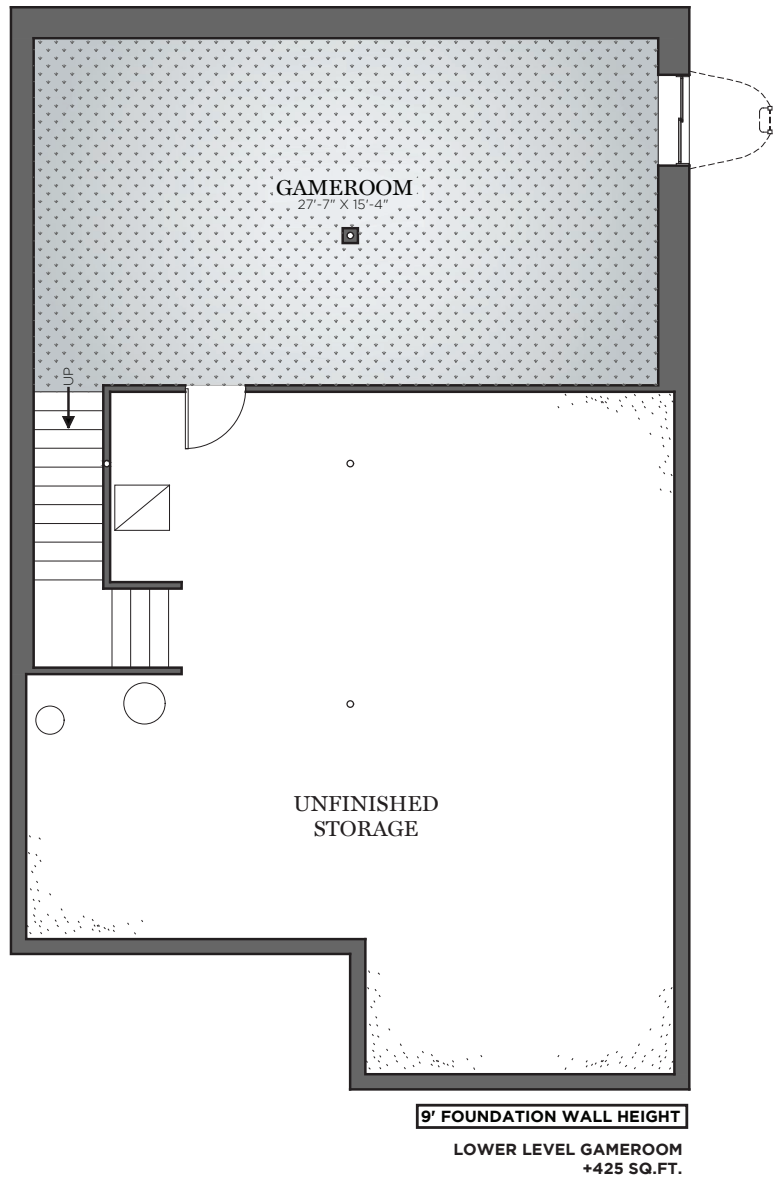

9' FOUNDATION WALL HEIGHT
LOWER LEVEL GAMEROOM
+425 SQ.FT.

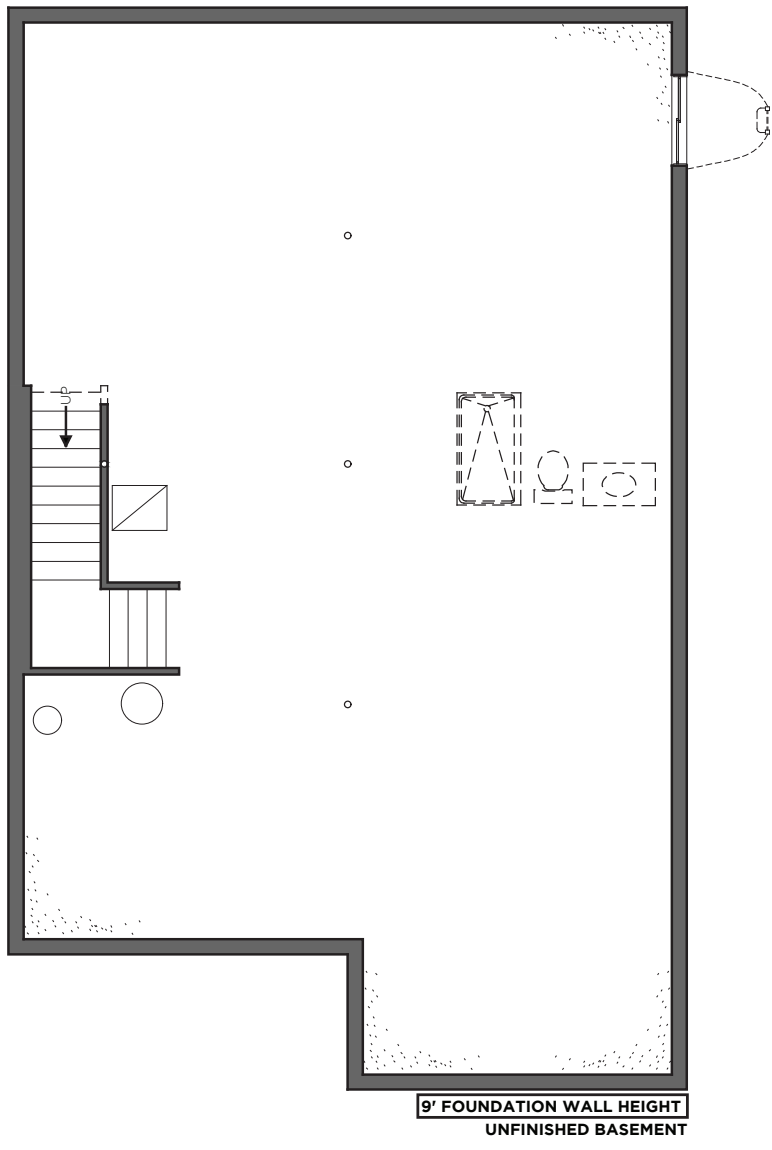

9' FOUNDATION WALL HEIGHT
UNFINISHED BASEMENT

LOWER LEVEL MODIFY FLOOR PLAN
 OA DIMENSION **30 X 48**

THE WALKER



CHARTER Homes & Neighborhoods

Information included is for illustrative and marketing purposes only. Scale and dimensions are approximate and may vary based on normal construction tolerances. Renderings, materials, finishes and fixtures are intended for space demonstration only. Consult Neighborhood Sales Manager for accurate details based on individual conditions of Purchase Agreement.

© 2016 Charter Homes & Neighborhoods. All rights reserved. Do not duplicate or distribute without written consent. 🏠